

ENJOYMENT WITHOUT LIMITS



418

ENJOYMENT WITHOUT LIMITS

빠르고 쉬운 세일링, 엘레강스한 디자인
그리고 특히 중요한 공간인 선수는 요트 오너들을
위해 특별하게 만들어졌습니다
한세 418은 새로운 기준을 정합니다
한세 418과 함께하는 항해에서 무한한 즐거움
그리고 잊을수없는 경험을 간직하세요.

Fast, easy sailing. In style, with an elegant design.
And an impressive area at the bow specially
created for the owner. The HANSE 418 sets new
standards. Enjoy unlimited pleasure and turn every
moment on board, on every voyage, into an unfor-
gettable experience.





바다 한가운데 에서 집의 아늑함을 느껴보세요.

The pen of judel/vrolijk & co와 세계 최고의 숙련된 요트 엔지니어들과의 합작으로 단단한 선체라인과 인상적인 세일 플랜을 가졌고, 최고 밸런스의 Rudder blade와 함께 빠른 스피드와 안전성을 오래 약속드립니다.

Feel at home on the high seas. The trademark fast hull line and the impressive sail plan come from the pen of judel/vrolijk & co, the world's best and most experienced yacht construction engineers. The combination of a perfectly harmonised lateral plan and a pre-balanced rudder blade are a further guarantee of high-speed performance and safety while you are sailing.

FAST CRUISING



Feel the pleasure of

COMFORT & SPEED

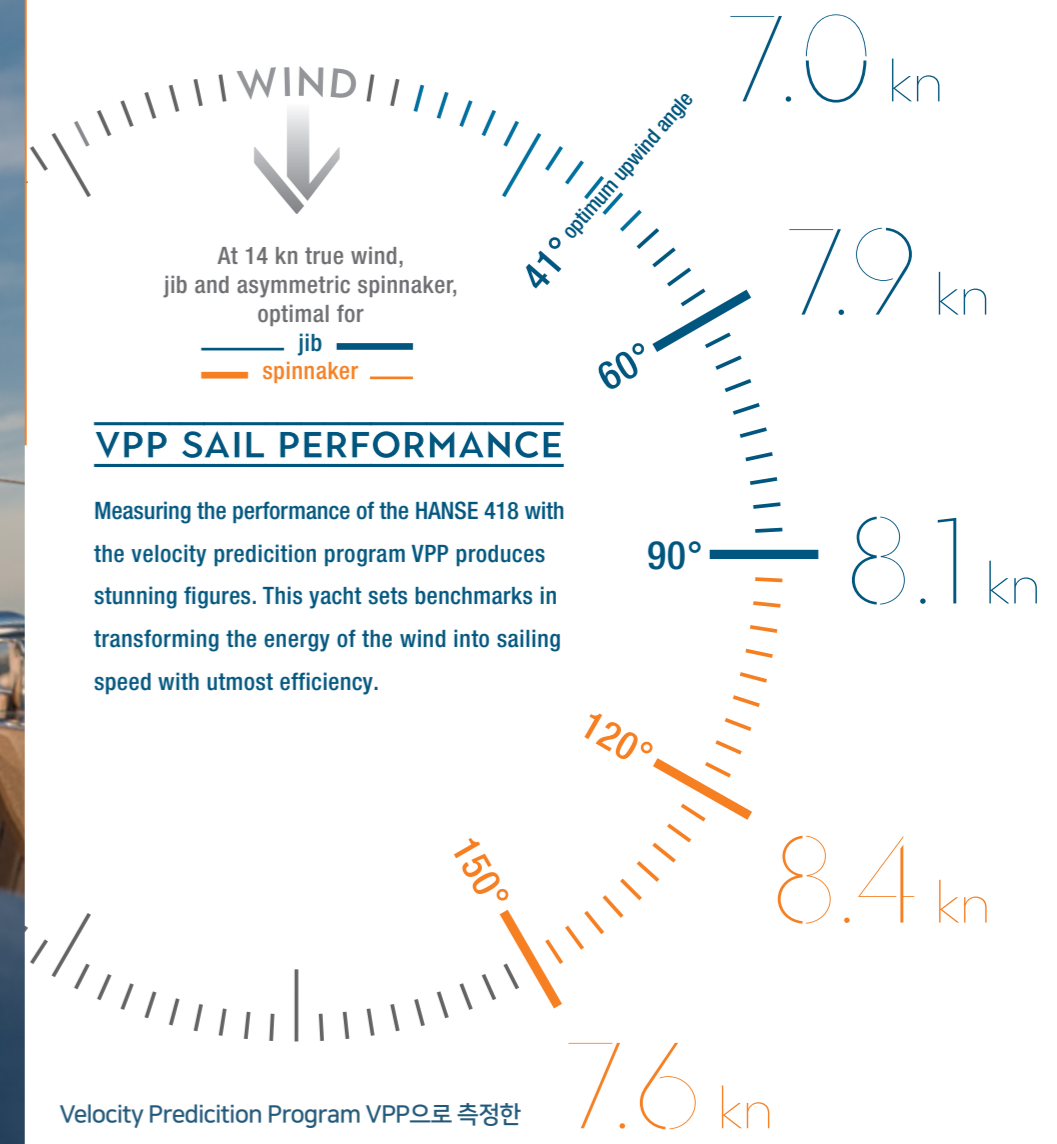

Velocity Prediction Program VPP으로 측정한 HANSE 418의 성능은 놀라운 수치를 보입니다. 바람의 에너지를 세일링 스피드로 전환하는 것에 있어서 아주 뛰어난 효율성을 보이며, 또한 모든 보트들의 본보기가 됩니다.

FAST CRUISING



RIG & SAIL OPTIMISATION

높게 디자인된 Rig는 HANSE의 트레이드마크입니다. Udel/vroljik & co의 디자이너는 오직 HANSE 각각의 모델들을 위해 정교하게 계산된 모델을 사용해 완벽하게 세일 플랜을 탄생 시켰습니다. 덕분에 HANSE요트는 동급 클래스 에서 가장 빠른 요트가 될수있었습니다.

A high rig is the trademark of every HANSE. The yacht designers from judel/vroljik & co perfectly form the sail plan for each HANSE with the use of highly sophisticated calculation models. This guarantees that you have the best sailing characteristics under all conditions, and it ensures your HANSE is one of the fastest yachts in its class.



아름답게 길게펼쳐진 HANSE만의 시그니처 워터라인

한세 418의 가파른 스트레이트형의 선미에서 놀라운 성능이 발현 되는데 이 똑똑한 디자인은 어떤 파도의 경사에서도 최적의 Waterline을 유지하며, 모든 항해 코스에서 우수한 스피드를 자랑합니다.

Outstanding performance comes from having a steep stern and a straight stem. This intelligent design provides an optimal, long waterline at any heeling angle – and superior speed for you on all courses.

FAST CRUISING



12
LOA .4 m

4
BEAM .1 m

2
DRAFT .1 m

DISPLACEMENT
.8 t



HANSE SMART TRIM SYSTEM

세일을 매끄럽게 조절 할 수 있도록 다듬었습니다.
앞에서든 뒤에서든 똑같이 좋은 퍼포먼스로 세일링을
할 수 있고, 마스트와 세일이 어떤 불규칙 한
바닷바람에서도 잘 적응할 수 있도록 도와줍니다.

We trimm the sails so you can sail like a pro and included
a backstay, which can be adjusted seamlessly. This enables
the mast and the profile of the sail to perfectly adapt to the
wind at all times.



FAST CRUISING



HANSE는 Easy Sailing 컨셉으로 시작된 요트입니다 또한 self-tacking jib을 개발함으로써 혼자서 요트를 컨트롤 할수 있고 세일링에 신경쓰지 않고 게스트들과 편하게 즐거운 시간을 보낼 수 있습니다. 스티어링에 많은 신경을 쓰지않으면서 모든 Reefing, Tacking 그리고 세일 셋팅이 가능하게 개발되었고, Deck는 line을 안쪽에 두게 됨으로써 더욱 깔끔해진 요트가 됩니다. HANSE 388은 바다 또는 마리나 에서 휴식을 취할때 최적의 편안함을 줍니다.

The HANSE Easy Sailing Concept is legendary. We invented the integrated self-tacking jib and brought all the lines to the helm. This means you can sail your yacht alone – or carefree while enjoying time with guests. Reefing, tacking and setting sail can all be performed from the helm without any effort. The deck is free of lines and fittings, giving you uncompromising comfort and space while you are at sea or relaxing in the harbour.

EASY SAILING



HANSE ONE-ROPE REEF SYSTEM

직접 세일구역을 조정할 수 있습니다. Cockpit에서 쉽게 조정 가능하며 HANSE One-Rope Reef System으로 빠르고 어떤 노력 없이 세일링을 가능케합니다.

You decide the size of the sail area – easily from the comfort of the cockpit. The HANSE One-Rope Reef System ensures that handling is quick and effortless for you.



PURE DECK & COCKPIT

깨끗하고 멋집니다. 모든 공간은 미니멀하게 디자인 되었습니다. 할야드와 슈트를 데크 아래로 넣음으로써 HANSE 458은 깔끔하고 간결한 구조를 가졌습니다.

Clean and cool. All spaces feature a minimalist design, with a pure and clear structure. We have even hidden the halyards and sheets elegantly below the deck.



HANSE SELF-TACKING JIB

Self-tacking jib 은 보다 쉽고 빠르게 요트를 운행 할 수 있게 도와줍니다 그리고 tack에서 또는 jibe 에서 헤드세일이 통합된 데크레일은 부드럽게 정확한 방향으로 조정합니다.

The self-tacking jib lets you easily and quickly manoeuvre the yacht. In the tack or the jibe, the headsail smoothly glides over the integrated deck rails automatically to the correct side.

EASY SAILING

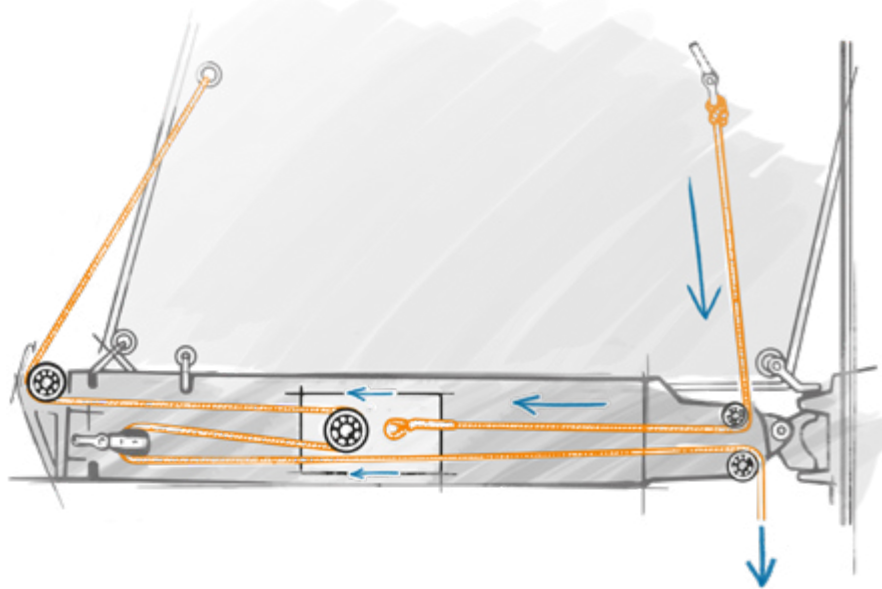

HANSE RUDDER BALANCE

우리는 뛰어난 밸런스의 러더를 개발했습니다. 러더 시스템의 디자인은 안전하면서도 상당히 민첩합니다. 평균보다 더 크게 만들어진 표면으로 효율성을 증대시켰고, 이로써 바다에서 어떠한 작은 플레이에서도 민첩성을 보입니다.

When it comes to the design of the rudder system, HANSE gives you high agility without compromising safety. For this, we have developed a pre-balanced rudder whose efficient surface is larger than average. It makes steering the yacht in any situation child's play.

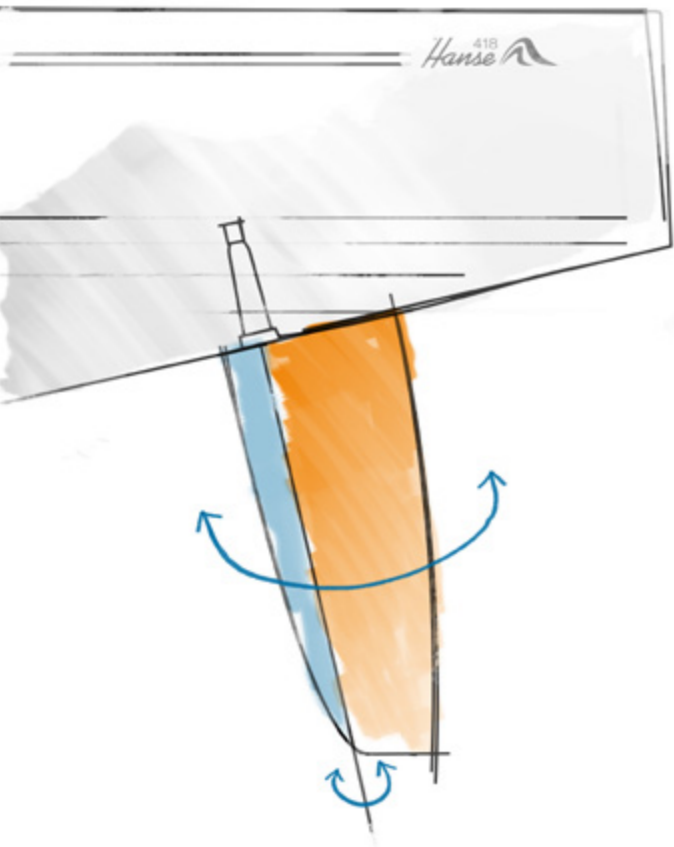

HANSE CROSSOVER SAIL

HANSE Crossover Sail은 Ultra-modern sail의 완벽함을 자랑합니다. 최고의 부품들과 기술로 만들어졌고 특히 이 세일의 특별함은 65도~140도의 바람에서도 조작이 쉽고 활용도가 아주 높다는 것입니다.

The HANSE Crossover Sail is the impressive result of an ultra-modern sail perfect for when you are on a reach course. Equipped with the finest components and technical finesses, this cutting-edge sail is unique in both its ease-of-use as a Genoa sail and its enormous spectrum of usage – from 65 to 140-degrees to the wind.

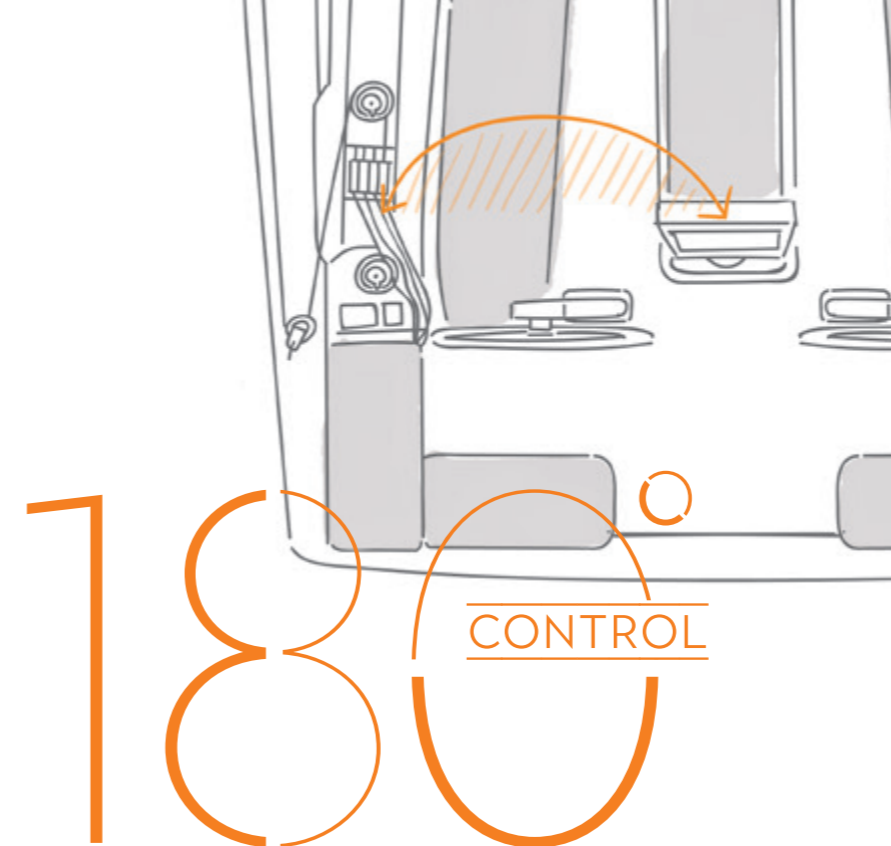

HANSE HELMSMAN CONTROL

버튼 터치 하나만으로 세일링을 해보세요. 한세와 함께 당신의 꿈이 실현될 것입니다. 전체 시스템을 컨트롤 하세요 cockpit 으로. 모든 halyards 와 sheets는 helmsman(조타실) 으로 이어져있습니다. 이것은 당신이 모든 세일링 동작을 컨트롤 할 수 있게 도와줍니다.

Sailing at the touch of a button? With HANSE, your dream is now reality! Control the entire system from the cockpit. All the halyards and sheets also lead to the helmsman. This gives you absolute control in all sailing manoeuvres.



EASY SAILING



HANSE와 함께 혁신적인 요트를 즐겨보세요. 테크니컬한 혁신과 퀄리티는 HANSE418의 많은 부분에서 확인할 수 있습니다. 감성적인 디자인과 웰빙 컨셉의 편안함을 자랑합니다. 수퍼리얼 디자인으로 요트 어느곳에서도 디테일을 느낄 수 있습니다. 이로써 최첨단 기술들과 예술성을 더해 완벽한 요트를 완성했습니다.

With HANSE, you have a progressive yacht that makes a statement. Technical innovations and quality in every detail are just as much part of the HANSE 418 as are an emotional design and comfortable atmosphere of well-being. Each detail is a subtle expression of superior design. The well-orchestrated ensemble of advanced technology and its integration is the highest art of yacht design at HANSE – and what drives us to create the perfect yacht.



INNOVATIVE DESIGN



HIGH EXTERIOR&INTERIOR LIGHTS



- 1 인체공학적 폴딩 설계의 조타석 2 두개의 스티어링 휠 3 스마트 사이드 로프 보관 데크
- 4 크롬으로 구성된 난간과 접이식 조종석 테이블 5 출입 계단옆 채광창 6 HANSE- self tacking jib
- 7 선수쪽 데크 채광창 8 수납공간이 많은 8인용 객실 9 밝고 넓은특징을 가지고있는 HANSE 디자인의 욕실과 싱크대 10 상단 찻장 11 접을수 있는 카드테이블과 등받이가 있는 소파
- 12 확장 가능한 패밀리 소파 13 접이식 폴아웃 바 테이블 14 많은 채광을 선사하는 선체 유리창
- 15 32인치 스크린 TV 16 밝고 넓은 스위트룸 전용 욕실

- 1 Ergonomic helmsman seats with folding function 2 Twin wheels 3 Rope storage cleverly integrated into the side deck 4 Cockpit table with fold-down tabletops as well as handrails and footrests made of chrome steel 5 Elegant glass skylights featuring opening portholes 6 HANSE self-tacking jib 7 Two hatches plus skylight for the most sunlight in a forecabin of this class 8 Eight-person cabin with lots of light and large wardrobes 9 Bright, spacious bathroom featuring HANSE designer sinks 10 Upper cupboards in the colours Grey or Dove Grey 11 Lowerable cards table to create a large chaise longue at the backboard 12 Extendable family saloon lounge 13 Saloon table with pull-out bar compartment 14 More daylight thanks to large hull windows 15 32-inch flat-screen TV 16 Bright and spacious owner's cabin, optional with exclusive en suite designer bathroom

SUN SPACE Unlimited

한세 418은 넓은 수평선을 바라볼수있는 시야를 제공하는것에 초점을 두고 있습니다

- 1 양옆의 있는 크고 혁신적인 유리 천창은 갑판 바로 아래에 햇빛을 안내하여 선실에서 놀랍도록 화사한 분위기를 연출합니다.
- 2 선실에서 태양과 바다를 아름답게 즐길수있습니다
- 3 널찍한 조종석과 플랫폼은 순수한 햇살 속에서 즐기고 실 수 있게 해줍니다.

The HANSE 418 focuses on providing open views and far-reaching horizons: **1** Large, innovative glass skylights on both sides of the companionway guide the sunlight directly below deck to create a wonderfully sunny ambience in the saloon and aft cabin. **2** The saloon offers a beautiful view of the sun and sea. **3** The spacious cockpit and the inviting bathing platform let you revel and relax in pure sunshine.



2



1



INNOVATIVE DESIGN



완벽한 이동의 자유를 위한 HANSE의 조종실 컨셉

- 1 스포티하고 우아한 휠이 장착된 트윈 컨트롤은 Y-spoke 디자인이 특징입니다.
- 2 HANSE에 의해 흥미진진하게 개발된 샤워기가 있는 티크플랫폼은 중앙 사다리로 인해 더욱 사용하기 쉬워졌습니다
- 3 스마트하게 측면 갑판에 통합된 로프보관함
- 4 접이식 조타석 덕분에 샤워 플랫폼에 자유롭게 접근이 가능합니다

The HANSE cockpit concept for full freedom of movement: **1** The twin control stations with sporty, elegant wheels featuring a Y-spoke design. **2** Developed exclusively by HANSE: easy-to-use bathing platform with teak and integrated bathing ladder. **3** Cleverly integrated into the side deck: the ropes storage at the control station. **4** Free access to the bathing platform thanks to foldable helmsman seats.





INNOVATIVE INTERIOR DESIGN

센스있게 스타일리시하게 : 우아하고 깔끔하게 어우러진 선들과 모서리들. 세련된 컬러의 일등급 패브릭과 대조되는 색조의 패브릭 패널들과 다양한 프리미엄 마감재 여유로운 선실의 디자인은 다양한 배치가 가능하며, 모든 공간에 햇빛과 은은한 밝기를 제공하도록 유도된 조명으로 인해 더욱더욱 센스있고 스타일리시한 인테리어가 됩니다

Sensationally stylish: modern, clear lines combine with elegantly rounded corners and edges. First-class fabrics in sophisticated colours, panels of contrasting textile hues, and a selection of premium finishes. The design of the spacious living area is available in various layouts and perfected with lighting guided to provide accents of sunlight and dimmable lamps in every space. It's the epitome of well-being across 41 feet.



HANSE 418은 바다에서 꿈을 실현합니다

- 1 HANSE 418은 넓은 공간, 전용 가구와 세부 옵션, 그리고 햇빛과 고정 조명 시스템의 독특한 조명 컨셉으로 오너와 손님들을 매료시킵니다
- 2 우수한 선호도를 가진 대조적인 섬유 패널 및 컬러의 마감 선택으로 개성있는 분위기를 연출할수있습니다.
- 3 스마트한 디테일들 : 다양하게 확장가능한 소파는 필요함에 따라 패밀리 라운지로 탈바꿈이 가능합니다

The HANSE 418 makes dreams at sea a reality: 1 The yacht fascinates owners and guests alike with its exceptional feeling of spaciousness, exclusive furnishings and details, and unique lighting concept of sunlight and in-scene light system. 2 A selection of fine fabrics, contrasting textile panels and coloured finishes create an individual ambience. Large windows offer a breathtaking view. 3 Smart details: the extendable bar compartment. The relaxing sofa can be turned into a family lounge as needed.



SPACIOUS & LIGHT

THE OWNERS CABIN



스위트룸 전용 욕실이 있는 편안한 마스터 객실. 두개의 커다란 창과 하늘빛이 HANSE 418의 선수를 동급중 가장 밝게 만듭니다. 저녁에 당신은 우아한 침대에 누워 별이 가득한 하늘을 볼수있습니다. 침대 상단에 있는 찬장은 수납공간을 충분히 제공하며 헤드보드 역할을 합니다

The comfortable master cabin, with exclusive en suite designer bathroom. Two large windows and a skylight make the bow of the HANSE 418 the lightest of its class. In the evening, you can look out at the starry sky directly from the elegant island bed. A cupboard at the top of the bed offers storage space and serves as a headboard thanks to the high-quality upholstery.

정교한 세부사항 1 현대적이고 투명한 피팅이 있는 독특한 천연 슬레이트는 HASNE 디자이너의 스타일 역량을 제공합니다.

2 HANSE 디자이너의 멋스러운 싱크대와 함께 가볍고 널찍한 욕실은 개인적인 용도가 많은 공간과 함께 편안한 헤드룸 을 제공합니다.

Sophisticated details: **1** Exquisite natural slate with modern, clear fittings provide designer accents of style. **2** The light, spacious bathroom with the attractive HANSE designer sink offers a host of space for personal care needs and a comfortable amount of headroom.

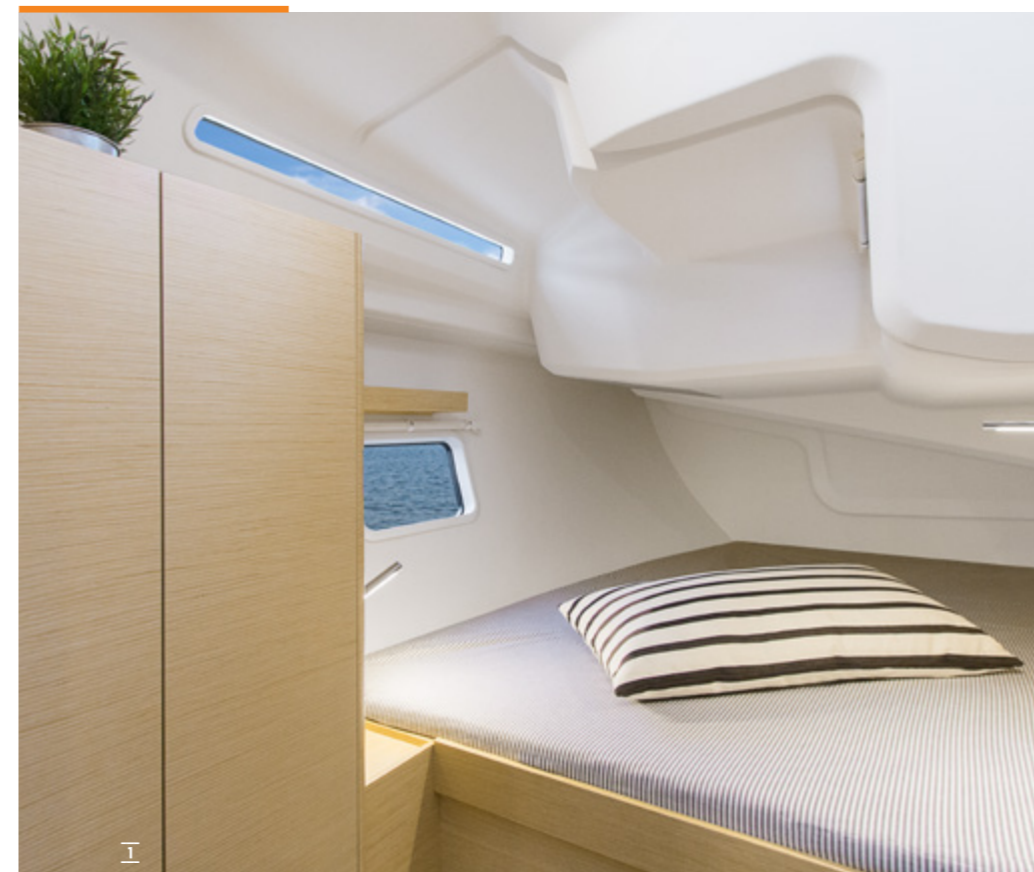

휴식을 위한 공간 1 뒷쪽 선실은 경치를 아름답게 바라볼수있도록 휴식 공간을 제공합니다
2 HANSE 디자이너의 멋스러운 싱크대와 함께 가볍고 널찍한 욕실은 개인적인 용도가 많은 공간과 함께 편안한 헤드룸 을 제공합니다. 그림 같은 조명과 넉넉한 옷장, 그리고 많은이동의 자유는 바다에서 편안함을 느끼게 해줍니다

Space for relaxation: **1** Like the saloon, the aft cabin provides a beautiful view of the water. Dimmable lighting, a very large wardrobe and lots of freedom of movement allow for a relaxing feeling of well-being here as well. **2** The backboard aft cabin features harmoniously integrated cupboards for even more storage space.



1 고급 소재로 제작된 실용적인 디테일로 우아한 마감처리 2 그리고 3 오너가 직접 스타일리쉬한 식료품 저장 공간을 디자인 할수 있습니다. 조리대에 Black Quartz 또는 Seashell White를 선택할수있습니다. 4 그리고 5 레이아웃을 선택 하고 다양한 색상 및 재료 옵션에 영감을 받으십시오. 모던한 프렌치 오크와 캐네디언 체스트넛(적갈색)으로된 회색차장으로 당신의 창의력을 한계가 없음을 보여주세요!

1 Elegant finishes are complemented by practical details made of high-quality materials. 2 and 3 You can design the stylish pantry yourself. Equipped with a worktop in Black Quartz or Seashell White. In the short or the long version. Whichever you choose, the HANSE developed refrigerator is always integrated and can be opened from the top or the front. 4 and 5 Choose your layout and be inspired by the many options in colours and materials. Whether modern in French Oak, or elegant in Canadian Chestnut with cupboards in Dove Grey, your creativity knows no limits.



SPACE FOR INSPIRATION

당신의 HANSE 418을 위한 다양한 배치와 표면의 예시를 통해 당신의 요트를 위해 영감을 얻으십시오. 다음 페이지에서 개별 실내 개념부터 목재, 패브릭 및 색상에 대한 다양한 옵션에 이르기까지 HANSE를 진정으로 자신만의 것으로 만드는 방법을 알아보십시오.

Be inspired for your own yacht with our examples of various layouts and surfaces for your HANSE 418. On the following pages, you will discover how you can make your HANSE truly your own – from individual cabin concepts to many options for wood, fabrics and colours.





CHOOSE ONE
ABSLOUTLY UNIQUE YACHT

당신이 향해하는 곳마다 당신의 한세는 특별한 존재다. 당신의 눈을 사로잡는 선체의 컬러를 선택할수있습니다.갑판 위에서 당신의 HANSE요트에 포함할 기술장비 옵션에 대한 결정은 전적으로 당신의 것입니다. 또한 인테리어는 당신의 시그니처가 될것입니다.해상에서 모던하고 우아함으로 둘러싸인 자유를 마음껏 누릴수 있게하는 고급소재와 전용설비가 당신을 기다리고 있습니다

Wherever you sail – your HANSE is one of a kind. You choose the colour of the hull and which upholstery you would like to catch your eye. On deck, the decision of which technical equipment to include on your HANSE yacht is all yours. The interior also carries your signature. Enjoy the freedom in the open sea in a modern loft atmosphere or surrounded by maritime elegance. High-quality materials and exclusive fittings await you.



INDIVIDUAL
CUSTOMISATION  418



사랑하는 사람, 가족 혹은 친구들과 함께 하고싶으십니까?
 HANSE 418의 하단 레이아웃은 당신의 개인적인 니즈를
 충분히 만족시켜 드립니다.
 여러명의 게스트를수용할수있는 클래식한 레이아웃 또는
 개인 맞춤형 컨셉을 고를수 있습니다

Do you prefer to sail with loved ones, your family or
 with a group of friends? The below-deck layout of
 your HANSE 418 can be adapted to your individual
 needs and desires. You can choose between the
 classic layout and a tailor-made cabin concept for
 many or just a few guests on board.

CABIN CONCEPT

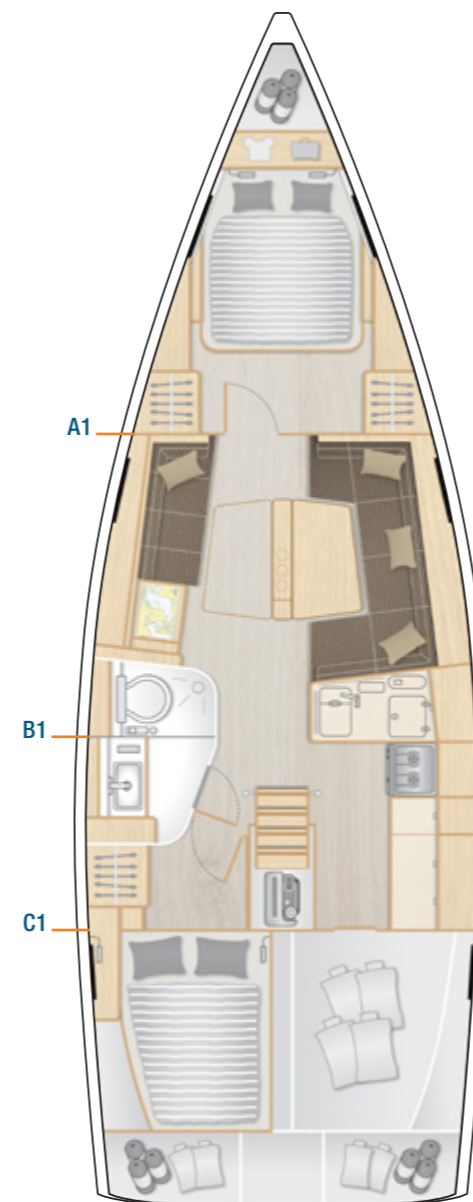

Standard

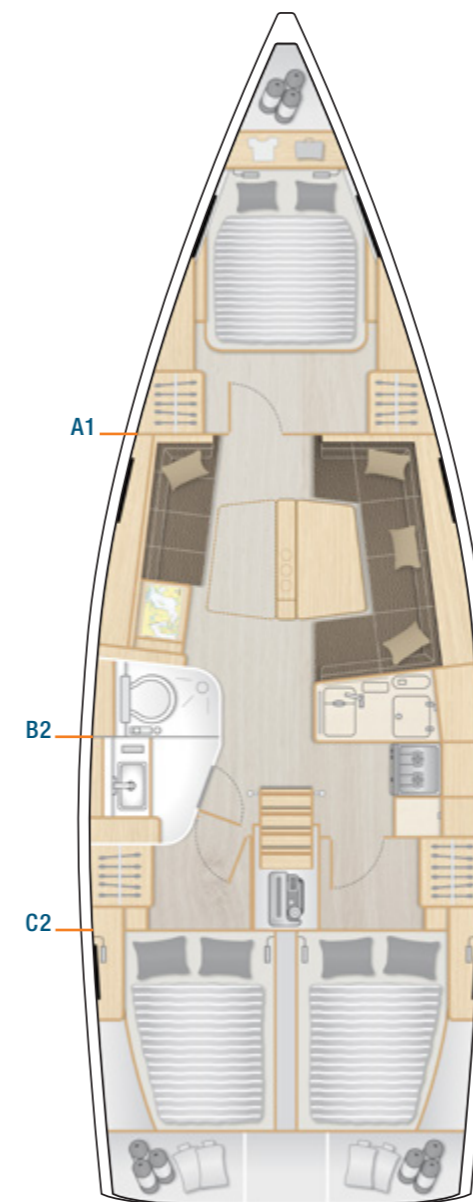

Option

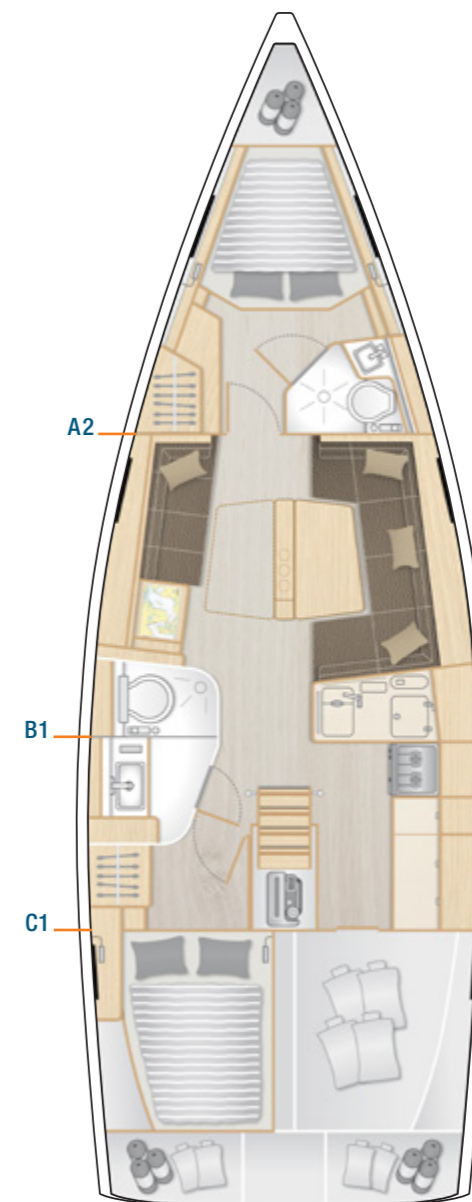

Option

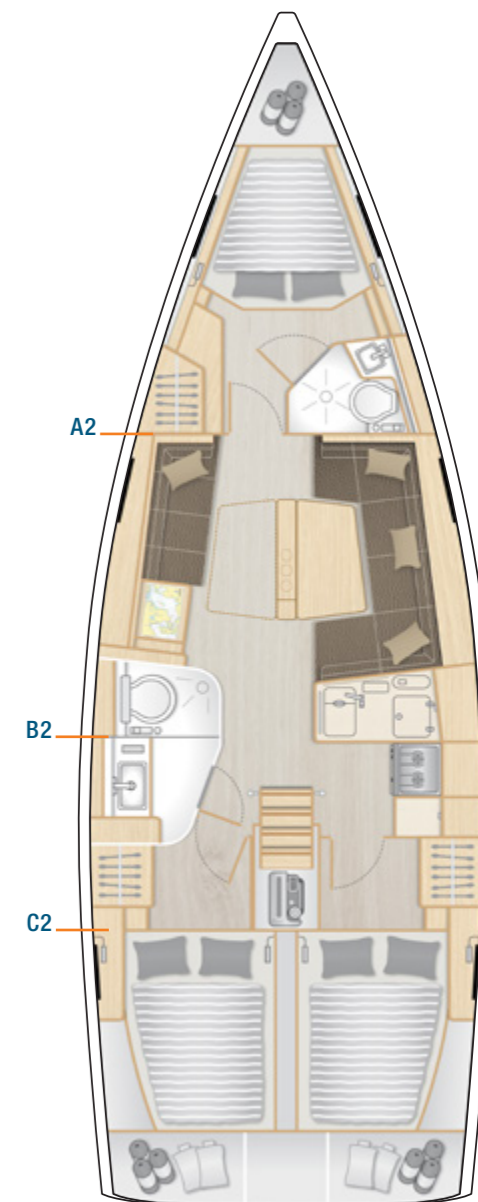

Option



TEAK DECK



TEAK & SYNTHETIC TEAK

Options: 1 Teak · Synthetic Teak: 2 Teak Black
 3 Teak Grey 4 Teak White 5 Scrubbed Black
 6 Scrubbed Grey 7 Scrubbed White 8 Weathered Black 9 Weathered White

GELCOAT

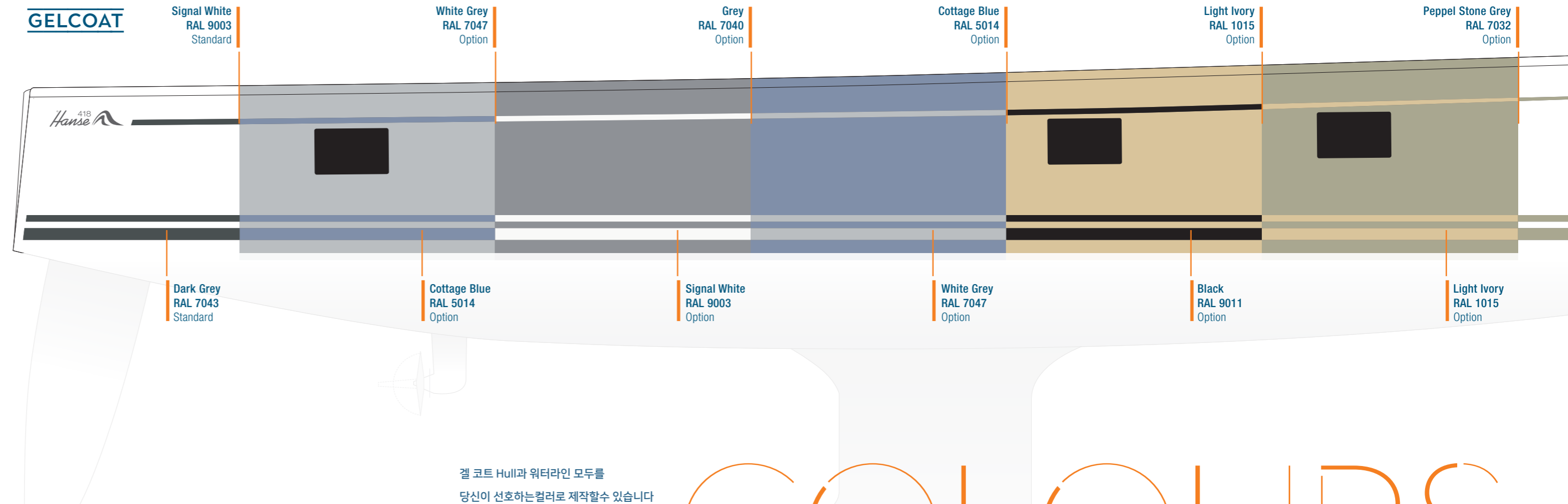

겔 코트 Hull과 워터라인 모두를
 당신이 선호하는 컬러로 제작할 수 있습니다

Gelcoat hull and waterline colours. At
 HANSE, you can select your individual
 colour for your new yacht.

COLOURS

HULL & WATERLINE

STYLE

CREATE YOUR OWN LIFE

당신만의 유니크한 개성을 위해 만들어진 단 하나의 요트.
 감각있는 Sail전문가 HANSE에서 당신의 창의력에 한계는 없습니다.
 우리의 전문가들은 당신의 취향을 완벽하게 실현할 수 있도록 최선을 다해 서포트 합니다.

Your own individual yacht for your unique personality. Discerning connoisseurs sail HANSE, as we offer you the chance to express your style personally. There are no limits to how creative you can be. Our experts are happy to support you in choosing the perfect accents.



CUSHIONS FOR COCKPIT . SUN BED . HELMSMAN SEATS

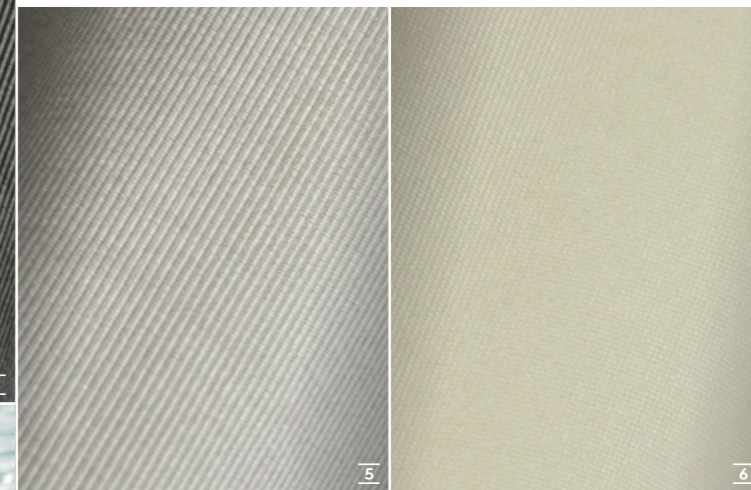
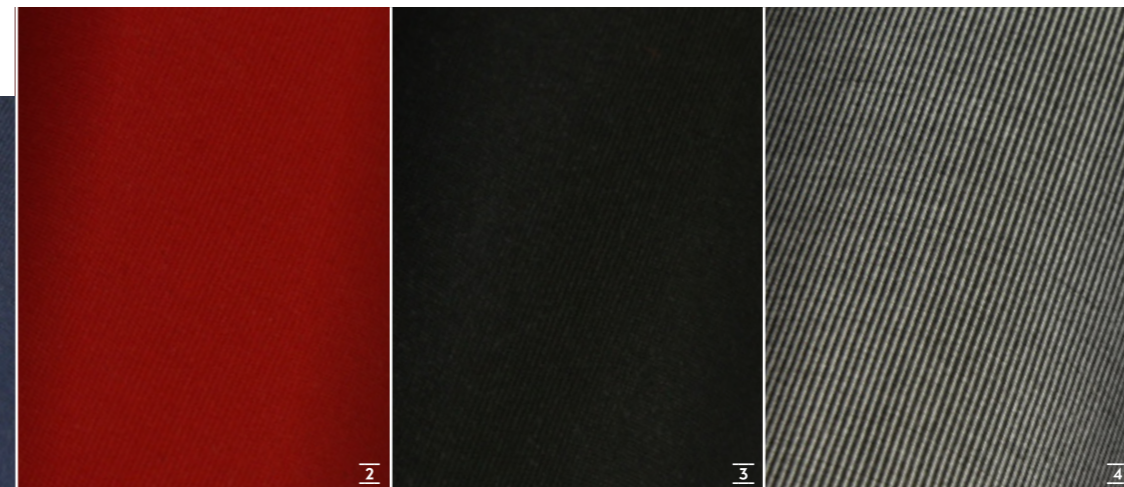

Options:
 1 Dark Blue 2 Red 3 Black 4 Dark Grey 5 Light Grey 6 Cream

LAZY BAG . BIMINI . SPRAYHOOD . COVER

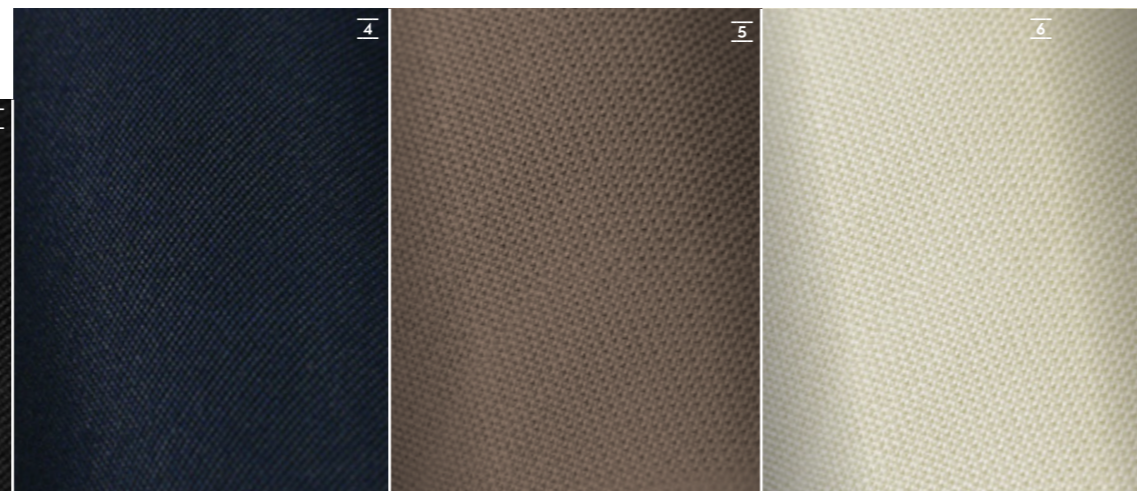
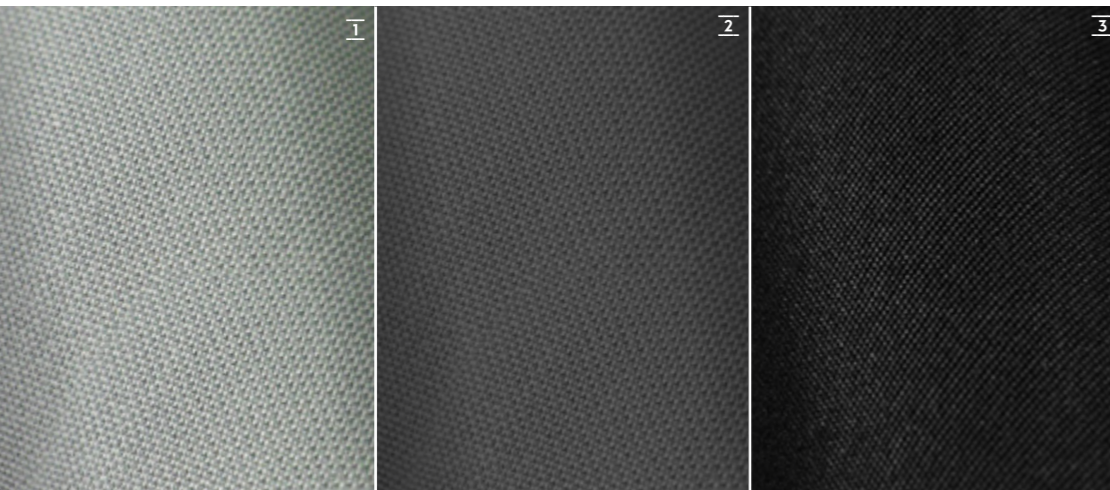

Options: 1 Light Grey 2 Dark Grey 3 Black 4 Dark Blue 5 Mineral 6 Cream



FURNITURE



Standard: **1** Mahogany Style Satin Varnish · Options: **2** Canadian Chestnut High Gloss **3** French Oak

CUPBOARDS

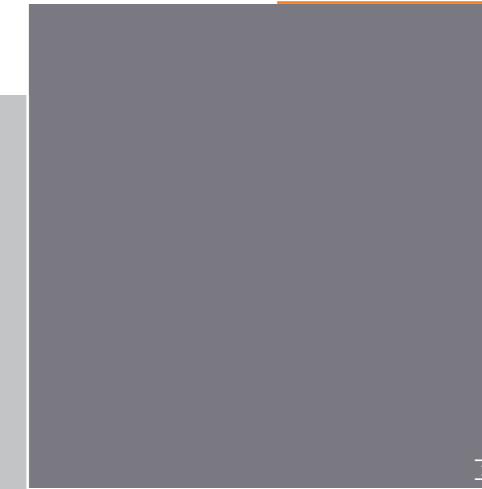
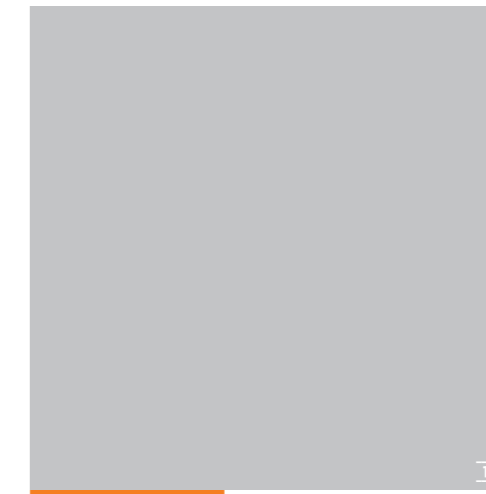

Options: **1** Pearl Grey **2** Dove Grey

FLOORBOARDS

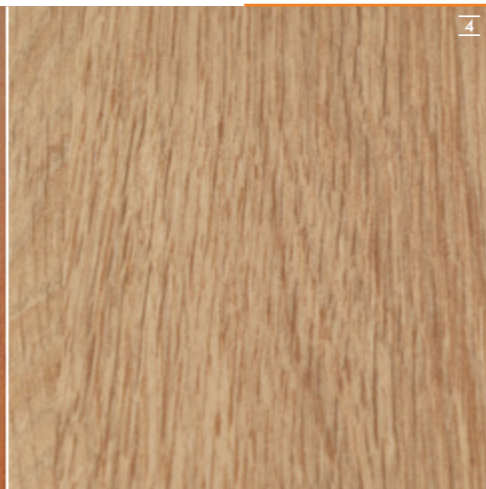
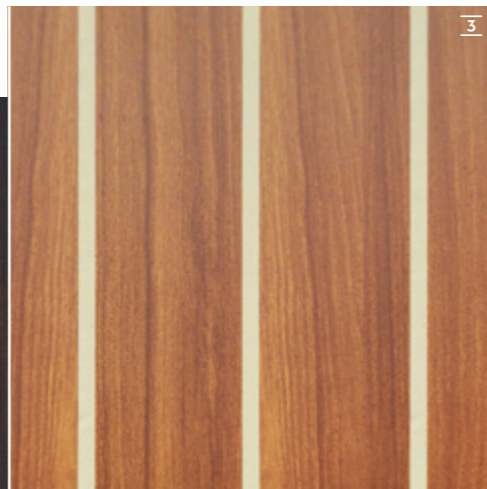
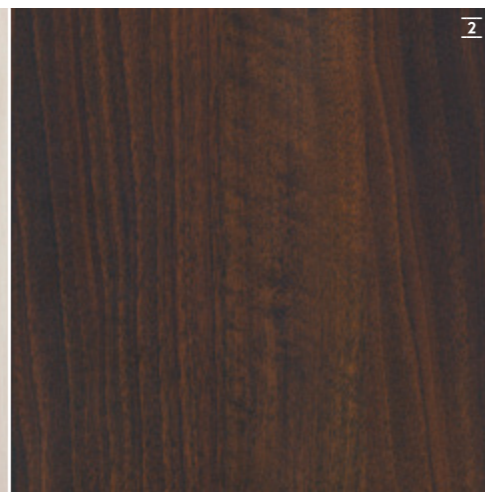
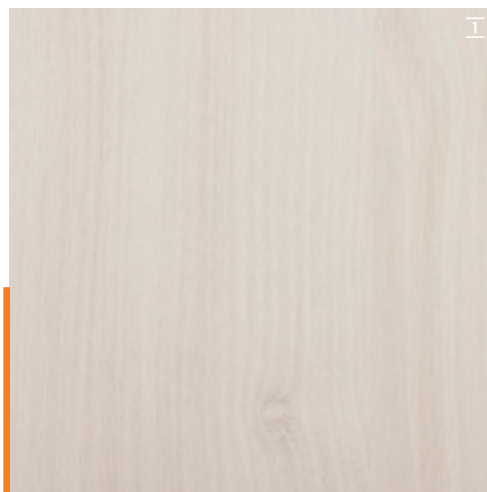

Standard: **1** Acacia · Options: **2** Noce Nero **3** Classic Stripes **4** Delight Oak

WORKTOP GALLEY

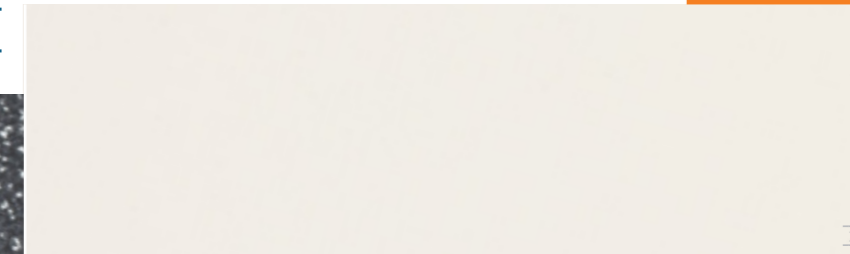
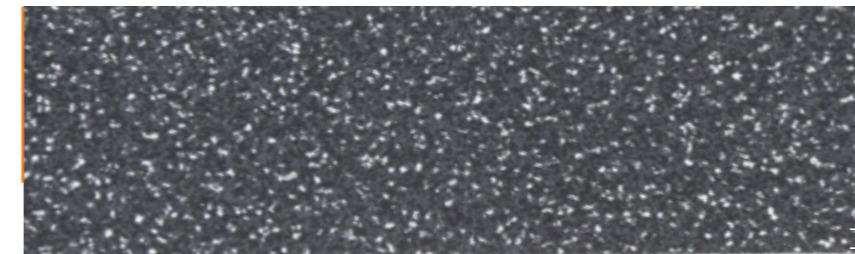

Standard: **1** Black Quartz · Option: **2** Seashell White

FABRICS INTERIOR

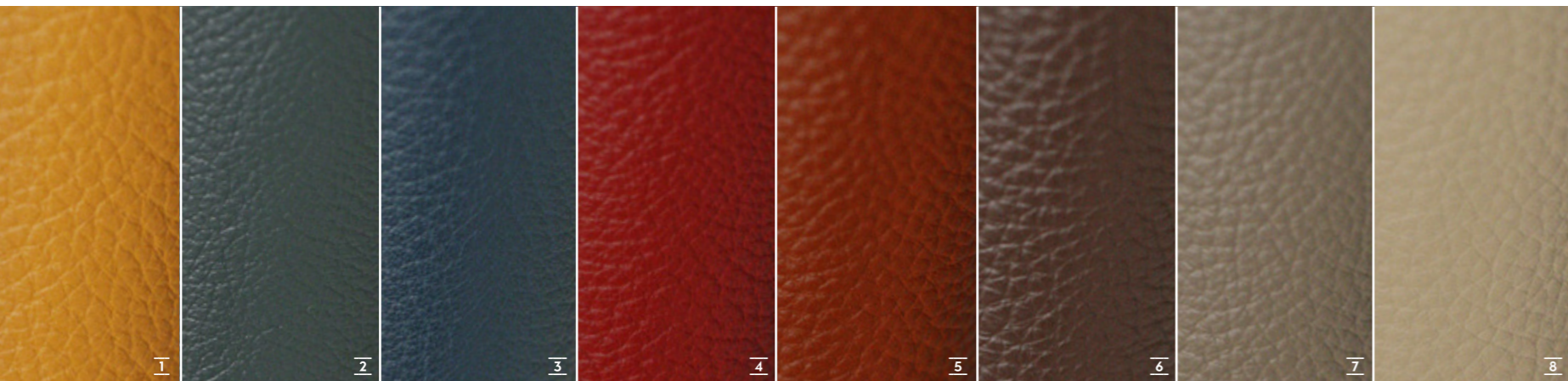

PORTOFINO LEATHER

Options: 1 Gold 2 Jade 3 Blue 4 Red 5 Auburn 6 Chocolate 7 Mud 8 Clay 9 Cream



VALENCIA

Options: 1 Cream 2 Beige 3 Brown 4 Red 5 Yellow
6 Light Green 7 Dark Blue 8 Light Grey



FLORENCE

Options: 1 Anthracite 2 Green 3 Chocolate
4 Brown Melange 5 Beige Melange 6 Nature

MONTE CARLO

Standard: 1 Cream · Options: 2 Sand 3 Chocolate
4 Red 5 Yellow 6 Blue 7 Dark Grey



1 Yellow 2 Red 3 Dark Blue 4 Light Blue 5 Black 6 Grey 7 White

GENNAKER

HANSE CROSSOVER SAIL

5노트 이상의 스피드에서 최적화
 세일 면적 93,00m²(ca.1.001 sq ft)
 해당 클래스에서의 최대 풍상각범위
 친환경 엔진사용
 셀프 태킹 Jib 시스템 장착
 추가분의 Forestay

- Sailing performance from 5 kn wind speed
- Sail area 76,90 m² (approx. 828 sq ft)
- Largest wind angle range in its class
- Green alternative to the engine
- Ideal complement to the self-tacking jib
- Additional forestay

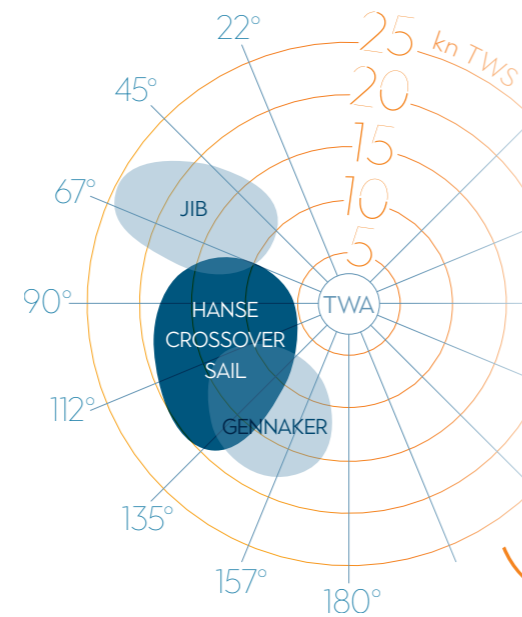

FAST CRUISING LAMINATE SAILS

최고의 성능을 위해 향상된 내구성
 야심찬 cruising을 위한 뛰어난 견고함
 올림픽 챔피언 Jesper Bank에 의해 특별히 설계된 디자인

- Increased stability for high performance
- High durability for ambitious cruising
- Exclusive Design by Jesper Bank for HANSE yachts



ELVSTRÖM FCL 5-LAYER PERFORMANCE TRIOPTIMAL SAILS
 올림픽 챔피언 Jesper Bank에 의해 특별히 설계된 디자인

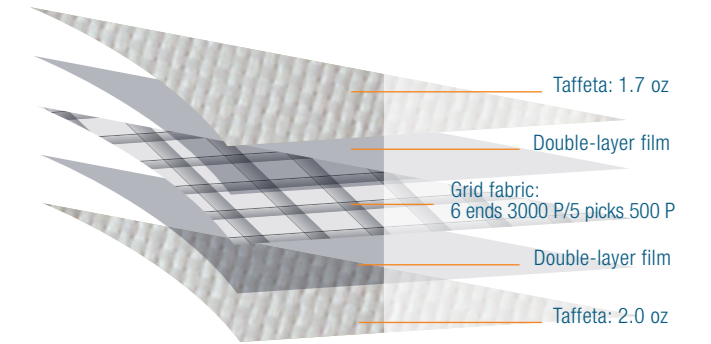

SAIL

FAST CRUISING LAMINATE SAILS

PERFORMANCE SAILS

NAVIGATION PACKAGE B&G



B&G Zeus³ 9" chart plotter
at cockpit table



B&G VHF V50
at chart table,
incl. wireless remote handset H50



B&G Autopilot
with Triton² control unit
and Precision 9 compass



2 B&G Triton² multifunction displays
in cockpit,
incl. transducer (wind/speed/depth/temperature)



VHF preparation with antenna and splitter for FM and AIS



UPGRADE 12" CHART PLOTTER



B&G Zeus³ 12" chart plotter
at cockpit table



TV PACKAGE SALOON

- TV preparation in saloon | Flat-screen LED TV in saloon
- DVB-T2 antenna for TV

ENTERTAINMENT PACKAGE SALOON & COCKPIT



FUSION MS-RA205 Multimedia Radio
with Bluetooth®
for saloon und cockpit |
FUSION MS-BT100 Bluetooth audio link



FUSION MS-NRX Remote Control
– Watertight control of all functions
in cockpit
– Control of iPod/iPhone music library
– Display of speed, depth, wind and
GPS via NMEA 2000 interface



2 high-end 2-way speakers
in saloon
2 high-end 2-way speakers
in cockpit
– Shock resistant, watertight



FUSION MS-AV750 Multimedia radio
with Bluetooth® and CD/DVD player,
for saloon und cockpit |
FUSION wireless link
remote control via mobile devices

NAVIGATION & ENTERTAINMENT

XTRAS

MORE

418

Die Optionsvielfalt von HANSE gibt Ihnen mehr Freiheit – räumlich und gestalterisch. Hier finden Sie ausgesuchte Extras für Ihre HANSE 418.

The variety of individual options at HANSE give you more freedom – spatially and artistically.

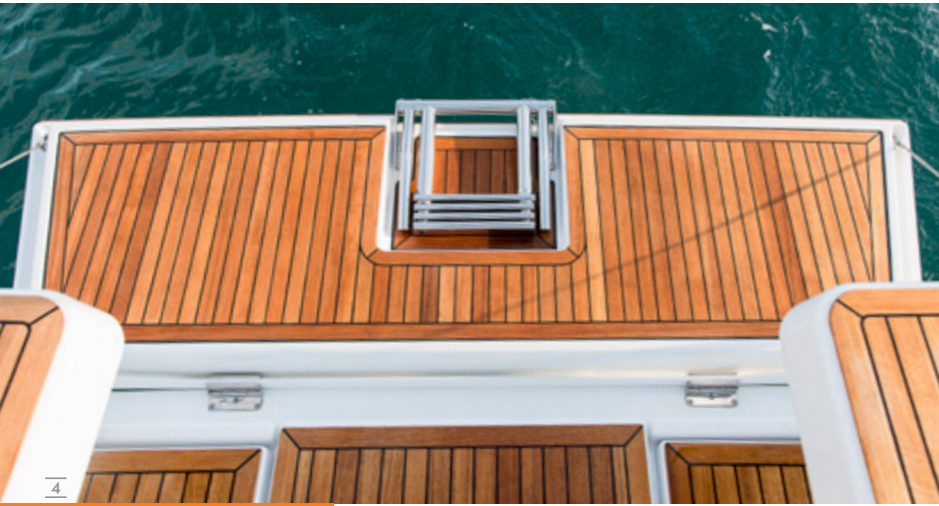

- 1 인체공학적 폴딩 설계의 조타석 2 우아한 표면 질감을 가진 합성티크와 천연티크 다양한 색상의 러닝테크를 가진 선실지붕 3 화이트 블랙 또는 화이트로 된 Y-SPOKE 카본라이트 휠
4 스테인리스강으로 만들어진 중앙 사다리를 갖춘 bathing platform 5 르우마르식 전자 윈치 6 접을수 있는 카드테이블과 등받이가 있는 소파
7 스테인리스강으로 만든 접이식 티크 테이블(저장 공간 및 냉장고 포함) 8 다양한 컬러로 즐길수있는 넉넉한 잭과 크래들

- 1 Ergonomic helmsman seats with fold-down function 2 Elegant teak or synthetic teak with genuine surface texture, in various colours on the running deck and the cabin roof 3 Carbonite wheels with a Y-spoke design in black or white 4 Large bathing platform with fixed, integrated bathing ladder made of stainless steel 5 Electric winches by Lewmar 6 Lowerable chart table for large chaise lounge at the backboard 7 Cockpit table made of stainless steel with fold-down teak tabletops, optional with storage space and refrigerator 8 Lazy bag with lazy jacks in various colours

ORIGINAL ACCESSORIES



MADE IN
GERMANY
SINCE 1990

기존의 인식을 깨뜨리고 새로운 트렌드를 만듭니다.
이는 우리의 캐치 프레이즈입니다.
하나 하나 완성된 요트와 함께 실현할 수 있도록
최선을 다합니다. 이약속은 당신이 바닷길을
경험하고 즐기면서 느낄 수 있을 것입니다.
다음 페이지에서 더 많은 정보를 확인해보세요

Breaking rules, setting trends. To us, this is more
than just a catchphrase. It is a commitment we
make a reality with each finished yacht. A com-
mitment you can feel, experience and enjoy sea
mile by sea mile. Discover more about this on
the following pages.



BREAKING RULES
SETTING TRENDS

“ HANSE는 눈에 띄는 디자인, 혁신적인 특성과 섬세한 가격책정으로 이 분야에서 성공스토리를 만들었습니다.”
Sailing Today Magazine

지금까지 HANSE 요트는 62개국 이상의 세계 어워드에서 수상했습니다.

To date, yachts made by HANSE have won more than 62 international awards.



6 OVER 7 ft

Jede fertiggestellte HANSE Yacht setzt Maßstäbe in technologischer Innovation, einfachem Handling und höchster Individualität. Das gilt bis in die höchste Bootsbau-Klasse

“ The HANSE 675 is a dream boat. Putting up the sails becomes a joyful experience: You can easily catch the wind and adjust to the wind strength. Mooring and anchoring



Bei berühmten Regatten feiern HANSE Yachten immer wieder große Erfolge, z.B. auf der Atlantic Rally for Cruisers, der Copa del Ray oder der Nordseewoche.

Time and time again, HANSE yachts achieve great successes in legendary regattas such as the Atlantic Rally for Cruisers, the Copa del Ray or the Nordseewoche.

“ Only boats with outstanding performance characteristics deserve the name HANSE.”
Dr Jens Gerhardt | CEO HANSE

HANSE는 세계적인 보트 디자이너 judel/vrolijk & co.와 함께 합니다. 첫 협업이었던 HANSE 371을 출시한 동시에 우리는 그 즉시 일류가 됐습니다.

HANSE create their yachts in cooperation with world-renowned boat designers judel/vrolijk & co. Our first joint development became an instant classic: the HANSE 371.



“ HANSE는 새로운 아이디어에 대한 지지 않는 열정이 있습니다. 그들과 함께 일하는 것은 기쁨이며 도전입니다.”
Rolf Vrolijk

CONTINENTS

전 세계의 세일링 선수들은 HANSE 요트를 선호합니다. 세계 1위의 요트 제작사로서 70개국의 딜러 네트워크를 형성하고 있습니다.

All over the world, sailing enthusiasts favour HANSE yachts. The international dealer network of the world's second-largest sailing yacht manufacturer delivers to 70 countries.

“ 세상의 끝에서 HANSE 요트는 독일처럼 상당히 탐나는 요트다.”
Anthony Bishop | Dealer, Australia

über 60 Fuss. | Each manufactured HANSE yacht sets a new benchmark in technical innovation, easy handling and extreme individuality. This also holds for the largest class in sailboat building over 60 feet.

are also one button push away.” Philippe Fornier | HANSE 675 owner



HANSE는 이 시대 최고의 발명가입니다.
가장 최근 발명품으로는 HANSE 315의 E-MOTION RUDDER DRIVE이 있습니다.

HANSE is best known for inventions that are surprising and indispensable at the same time. The latest example is the E-MOTION RUDDER DRIVE of the HANSE 315.

“ HANSE는 진정한 21세기 요트를 제작합니다. 현재를 만들고 미래를 만들어갑니다. ”

Raoul Bajorat | Head of Development HANSE



1,500 OPTIONS

“ 당신은 어디에서도 HANSE 보다 더 커스터마이징한 요트를 찾을 수 없을 것입니다. ”
Maxim Neumann | Sales Director HANSE

다양한 커버와 목재가구 그리고 카페트로 개인선호를 담은 수천가지의 가구배치를 제공할 수 있습니다. 폭넓은 선택권은 HANSE를 더욱 유니크하게 만들어줍니다.

Thanks to the wide range of upholstery, furniture wood and carpets, we offer thousands of individual furnishing arrangements. A wide choice like this is unique in the market.

89



EXPERTS

HANSE의 890명의 직원들 모두는 세일링에 열정을 가진 사람들로 구성되어 있습니다. 최신식 생산 프로세스와 함께 그들의 열정을 모아 서로 손을 맞잡았습니다.

At HANSE, 890 dedicated sailing enthusiasts work together hand in hand. Supported by cutting-edge production processes. Driven by total commitment to their profession.

“ 고객과 우리는 같은 생각을 가졌습니다. 흠 잡을 것 없는 최고의 요트로 세일링 하는 것 만큼 더 즐거운 것은 없습니다. ”

Pascal Kuhn | Product Marketing HANSE

1990년대 초반, 초기의 HANSE는 보트 제작에 혁명을 불러왔습니다. 통합 셀프 태킹 jib 시스템의 출시가 그 첫번째입니다.

In the early 1990s, the very first HANSE started a revolution in boat building. It featured the first integrated self-tracking jib ever produced in series.

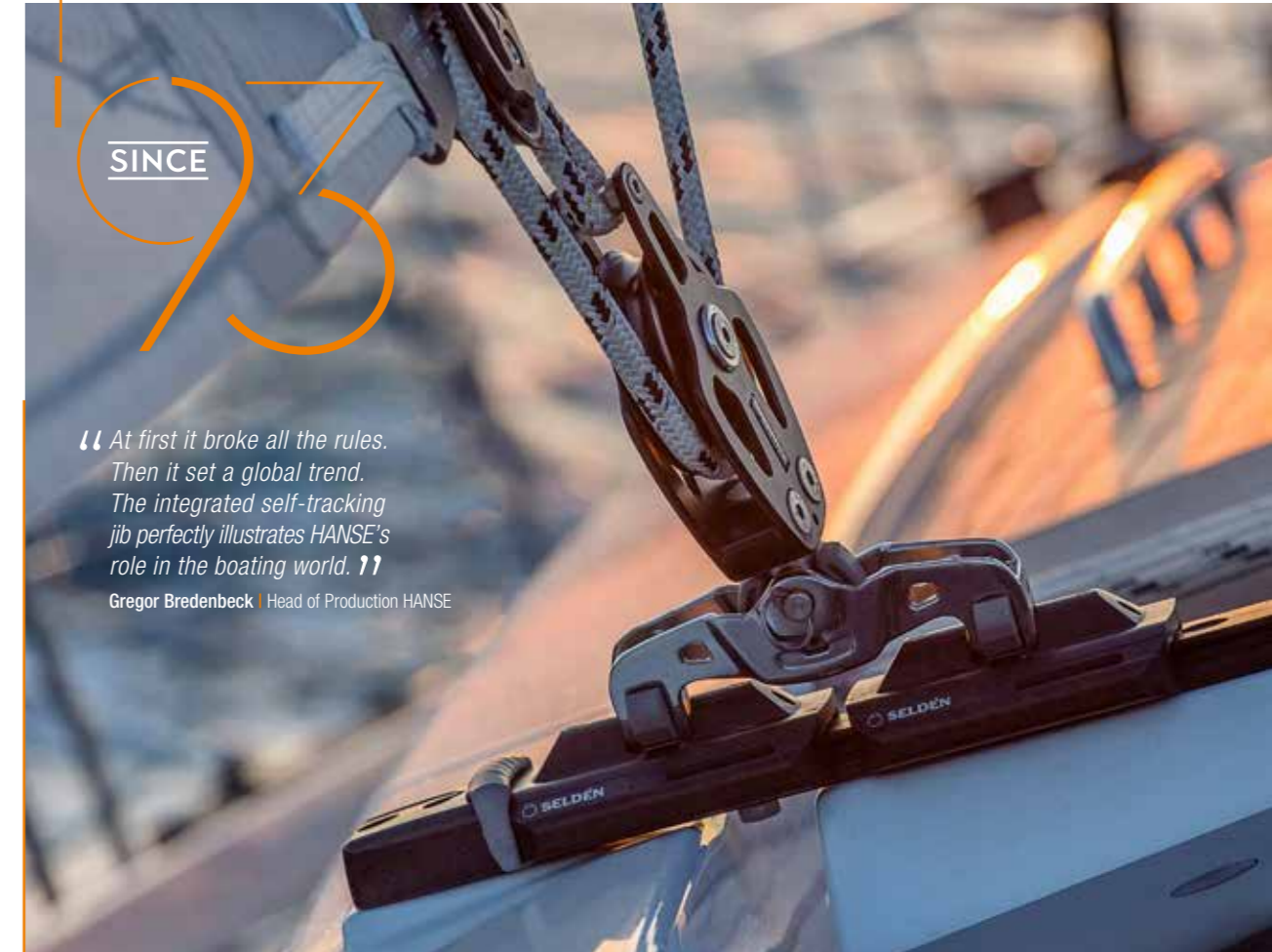

“ At first it broke all the rules. Then it set a global trend. The integrated self-tracking jib perfectly illustrates HANSE's role in the boating world. ”
Gregor Bredenbeck | Head of Production HANSE



HANSE 요트는 모든 디테일이 인상적입니다.
감히 당신의 숨을 멎게 할 만큼 가히 걸작이라고 할 수 있습니다.
그 디자인은 완벽한 하모니를 이루는 앙상블과 가장 현대적인
테크놀로지 그 이상입니다. 그들의 요트에 대한 열정은 한치의
오차도 없는 정확성에서 느낄 수 있습니다.
HANSE의 모든 디테일에서 확인하세요.

Impressive in every detail, HANSE yachts are masterpieces
made to take your breath away. They are far more than
a perfectly harmonised ensemble of design and the most
modern technologies. They reflect the experience and
know-how of HANSE engineers. Their passion for yachting
can be felt in the unmistakable precision and meticulous
detailing found in every HANSE.



HANSE

ENGINEERING



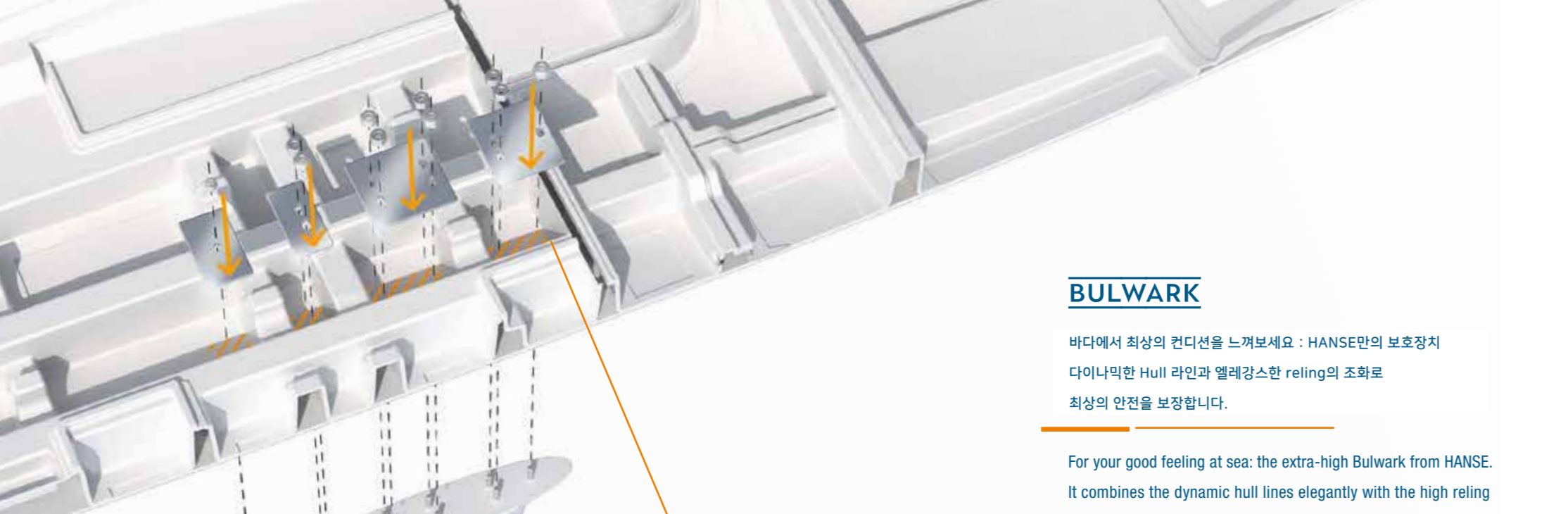

BULWARK

바다에서 최상의 컨디션을 느껴보세요 : HANSE만의 보호장치
다이나믹한 Hull 라인과 엘레강스한 reling의 조화로
최상의 안전을 보장합니다.

For your good feeling at sea: the extra-high Bulwark from HANSE.
It combines the dynamic hull lines elegantly with the high reling
and thus ensures a maximum of safety.

KEEL HULL CONNECTION

킬 플레이트는 에폭시 수지로 만들어진 초경량 배드에
안전하게 장착이 되어 있으며, 킬은 파워풀한 바닥
연결장치에 단단히 고정되어 있습니다.
또한 킬 볼트는 디스크와 너트를 포함하여
스테인레스 철강으로 견고하게 만들어졌습니다

Safety first. The keel plates lie securely in an ultra-
strong bed made of epoxy resin. This means that
the keel is directly anchored in the powerful floor
structure. The keel bolts, including discs and nuts,
are made of stainless steel.



SANDWICH CONSTRUCTION

HANSE 418 은 높은 퀄리티의 sandwich process로 제작됩니다.
선체는 엄선한 소재로 여러겹 덧대어졌으며, 모든 디테일에 정교함을 담았습니다.
특히 내부의 vinylester 소재 덕분에 특히 가벼우며 완벽하게 삼투현상을 막아줍니다.

The HANSE 458 is constructed using the high-quality sandwich process. The hull
features several layers of select materials and is precisely calculated in every detail.
It is particularly lightweight and, thanks to the exterior vinylester layer, completely
resistant to osmosis.



- Stainless steel bolts
- Deck
- Best formulated performance glue
- Hull
- Threaded aluminum plate

HULL-DECK CONNECTION

judel/vroljik & co, 과의 협업으로 HANSE는 일반적인 수준을 뛰어넘는
특별한 hull-deck connection을 사용하고 있습니다.
또한 매우 튼튼한 폴리에스테르 본딩수지를 사용하여
견고한 torsion-free 요트를 만들었습니다.

In collaboration with judel/vroljik & co, HANSE has developed a special hull-deck
connection which goes well beyond all standard requirements. In addition to the
use of highly robust polyester bonding resin, the deck and hull are anchored with
the use of high-strength bolts in the cleats. This results in a stable, torsion-free yacht
with a sporty character.



- GRP laminate
- Core-Mat
- GRP laminate
- Vinylester
- Gelcoat



418

SPECIFICATIONS



Beam 4.17 | 13'8"



LOA 12.40 m | 40'8"

LOA / 전체길이		12.40 m	40'8"
Hull length / 선체길이		11.99 m	39'4"
LWL / 워터라인 길이		11.40 m	37'5"
Beam / 폭		4.17 m	13'8"
Draft / 흘수			
L-keel, medium / 미디엄 킬		2.10 m	6'11"
L-keel, shallow / 저수심 킬		1.74 m	5'9"
Displacement / 배수량			
L-keel, medium 미디엄 킬	approx.	9.8 t	21,605 lbs
L-keel, shallow 저수심 킬	approx.	10.10 t	22,267 lbs
Ballast / 바닥하중			
L-keel, medium 미디엄 킬	approx.	2.86 t	6,305 lbs
L-keel, shallow 저수심 킬	approx.	3.20 t	6,945 lbs
Engine diesel / 디젤엔진			
Standard / 표준	approx.	39.00 PS	39.00 HP
Option / 옵션	approx.	57.00 PS	57.00 HP
Fuel tank / 연료탱크	approx.	160 l	42 gal
Fresh water / 청수	approx.	475 l	125 gal
CE certification 유럽규격	A - 10		
Design 디자인	judel/vrolijk & co		
Interior 인테리어	HanseYachts Design		

마스트 길이	approx.	19.60 m	64'4"
총 세일 면적	approx.	87.00 m ²	936 sq ft
메인세일	approx.	52.50 m ²	565 sq ft
Self-tacking jib	approx.	34.50 m ²	371 sq ft
크로스오버	approx.	76.90 m ²	828 sq ft
제네이커	approx.	120.00 m ²	1,292 sq ft
마스트			
I		16.59 m	54'5"
J		4.70 m	15'5"
P		16.17 m	53'1"
E		5.57 m	18'3"

All measurements are approximate. Specifications and materials can be change without notice. Errors excepted.



This brochure is not contractual. The yachts depicted partly comprise special equipment not included in the standard scope of supply. Illustrations may not correspond with current versions. Subject to alterations in design and equipment without notice and errors excepted. Photos/Illustrations: HanseYachts; Nico Krauss; Peter-Paul Reinmuth; Björn Willer; Jude/Vrolijk & co; Malwin Faber; BGG; Fusion; Elvstrom; iStock; Eivaisla + Dzevonlia - Design: design-harksen.de & ulfson.de | Print: Druckhaus Panzig

CIB418/B/0118